

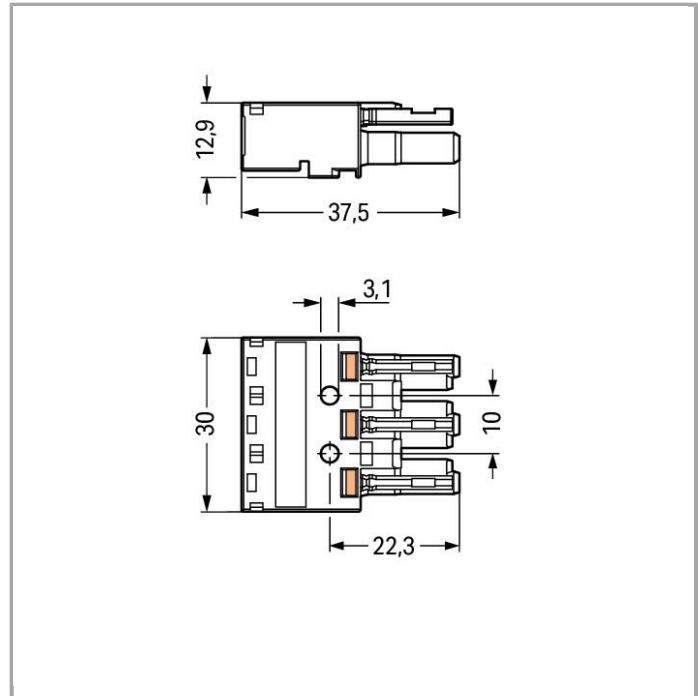

Data sheet | Item number: 770-203

Socket; 3-pole; Cod. A

www.wago.com/770-203

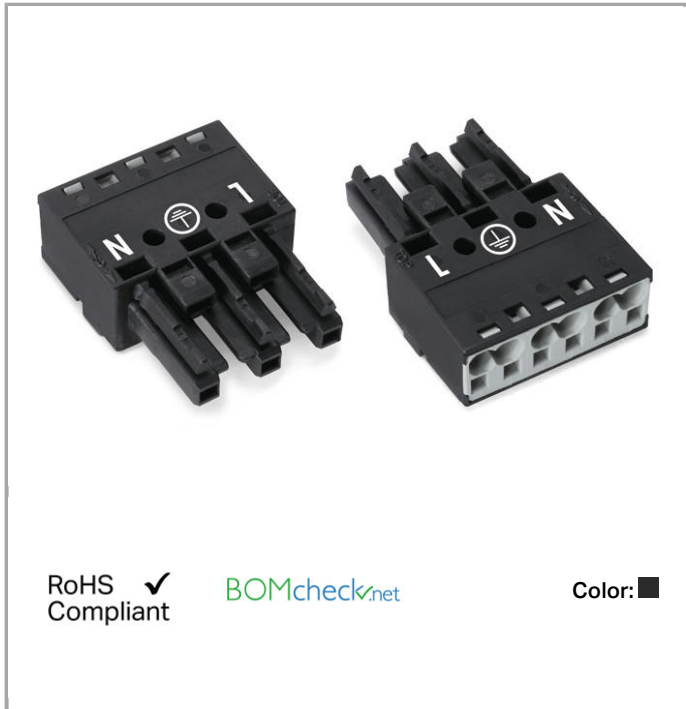

Item description

Black coding A (L N)

Note:

All connectors for mounted installations (snap-in versions for lighting fixtures or devices, all types of PCB and distribution connectors) are factory-equipped with locking levers to ensure plugs and sockets are securely locked. Additional locking levers are only required for flying leads (plug /socket).

Data

Electrical data

Ratings per IEC/EN 60664-1

Rated voltage (III / 3)	250 V
Rated impulse voltage (III / 3)	4 kV
Rated current	25 A
Legend (ratings)	(III / 3) ≙ Overvoltage category III / Pollution degree 3

Connection data

Connection technology	Push-in CAGE CLAMP®
Actuation type	Operating tool Push-in
Nominal cross section	4 mm ²
Solid conductor	0.5 ... 4 mm ² / 20 ... 12 AWG
Solid conductor, push-in termination	1.5 ... 4 mm ² / 16 ... 12 AWG
Stranded conductor	0.5 ... 2.5 mm ² / 20 ... 14 AWG
Fine-stranded conductor	0.5 ... 4 mm ² / 20 ... 12 AWG
Fine-stranded conductor with ferrule with plastic collar	0.25 ... 1.5 mm ² / 20 ... 16 AWG
Fine-stranded conductor with ferrule without plastic collar	0.25 ... 2.5 mm ² / 20 ... 14 AWG
Fine-stranded conductor with ferrule, push-in termination, from	1.5 mm ² / 16 AWG
Strip length	9 mm / 0.35 Inch
Note (strip length)	see also packaging or instructions
No. of poles	3
Total number of connection points	6
Total number of potentials	3
Conductor entry direction to mating direction	0°
Number of test slots	3

Geometrical Data

Pin spacing	10 mm (0.394 inch)
Width	30 mm / 1.181 inch
Height	12.9 mm / 0.508 inch
Depth	37.5 mm / 1.476 inch

Mechanical data

Coding	A
Mating force of a plug-in connection	approx. 20 ... 70 N (depending on pole number)
Retention force of a plug-in connection	when locked: > 80N
Unmating force of a plug-in connection	when unlocked: approx. 20 ... 70 N (depending on pole number)
Marking	L N
Degree of protection	IP20
Potential marking	L N

Plug connection

Contact type (pluggable connector)	Female connector/socket
Connector connection type	for conductors
Mismating protection	Yes

Locking of plug-in connection	locking lever
Locking lever	no

Material Data

Color	black
Insulating material	Polyamide 66 (PA 66)
Flammability class per UL94	V0
Clamping spring material	Chrome nickel spring steel (CrNi)
Contact material	Copper or copper alloy, surface-treated
Fire load	0.157 MJ
Weight	9.405 g

Environmental Requirements



Surrounding air (operating) temperature	-35 ... 85 °C
-----------------------------------------	---------------

Commercial data

Country of origin	DE
GTIN	4044918252225
Product Group	20 (WINSTA)

Approvals / Certificates

Country specific Approvals

Logo	Approval	Certificate name
	CCA DEKRA Certification B.V.	NL-32105
	CCA DEKRA Certification B.V.	2173495.02
	VDE VDE Prüf- und Zertifizierungsinstitut	40002889

Ship Approvals

Logo	Approval	Certificate name
	ABS American Bureau of Shipping	14-HG1241528-PDA
	DNV GL Det Norske Veritas, Germanischer Lloyd	TAE00001Z6



LR
Lloyds Register







02/20050 (E6)

UL-Approvals

Logo	Approval	Certificate name
	cURus Underwriters Laboratories Inc.	E45171 Sec. 9

Compatible products

Strain relief plate

	Item no.: 770-503 Strain relief housing; 3-pole; for 2 cables; 8.0 ... 11.5 mm; 55 mm	www.wago.com/770-503
	Item no.: 770-503/021-000 Strain relief housing; 3-pole; for 1 cable; 9.0 ... 13.0 mm; 71 mm	www.wago.com/770-503/021-000
	Item no.: 770-503/023-000 Strain relief housing; 3-pole; for 2 cables; 4.5 ... 8.0 mm; 55 mm	www.wago.com/770-503/023-000
	Item no.: 770-503/032-000 Strain relief housing; 3-pole; with locking clip; for 2 cables; 8.0 ... 11.5 mm; 55 mm	www.wago.com/770-503/032-000
	Item no.: 770-503/035-000 Strain relief housing; 3-pole; with locking clip; for 1 cable; 7.0 ... 11.5 mm; 48 mm	www.wago.com/770-503/035-000
	Item no.: 770-503/038-000 Strain relief housing; 3-pole; with locking clip; for 1 cable; 7.0 ... 11.5 mm; 48 mm	www.wago.com/770-503/038-000
	Item no.: 770-513 Strain relief housing; 3-pole; for 1 cable; 8.0 ... 11.5 mm; 55 mm	www.wago.com/770-513
	Item no.: 770-513/021-000 Strain relief housing; 3-pole; for 1 cable; 9.0 ... 13.0 mm; 71 mm	www.wago.com/770-513/021-000
	Item no.: 770-513/023-000 Strain relief housing; 3-pole; for 2 cables; 4.5 ... 8.0 mm; 55 mm	www.wago.com/770-513/023-000



Item no.: 770-513/032-000
Strain relief housing; 3-pole; for 2 cables; 8.0 ... 11.5 mm; 55 mm

www.wago.com/770-513/032-000



Item no.: 770-513/035-000
Strain relief housing; 3-pole; with locking clip; for 1 cable; 7.0 ... 11.5 mm; 48 mm

www.wago.com/770-513/035-000



Item no.: 770-513/038-000
Strain relief housing; 3-pole; with locking clip; for 1 cable; 7.0 ... 11.5 mm; 48 mm

www.wago.com/770-513/038-000

shield connection



Item no.: 770-523
Shield connecting plate; for 3-pole plugs and sockets

www.wago.com/770-523

tools



Item no.: 210-720
Operating tool with partially insulated shaft; Type 2, blade (3.5 x 0.5) mm

www.wago.com/210-720



Item no.: 770-383
Operating tool; 3-way

www.wago.com/770-383

Locking lever

Item no.: 770-101
Locking lever; manually operated; for "flying leads"

www.wago.com/770-101



Item no.: 770-111
Locking lever; tool operated; for "flying leads"

www.wago.com/770-111



Item no.: 770-121
Locking lever; manually operated; for "flying leads"

www.wago.com/770-121



Item no.: 770-131
Locking lever; tool operated; for "flying leads"

www.wago.com/770-131

Marking accessories



Item no.: 770-450
Marker card; for manual marking

www.wago.com/770-450



Item no.: 770-450/000-001
Marker card; for manual marking

www.wago.com/770-450/000-001



Item no.: 770-450/000-002
Marker card; for manual marking

www.wago.com/770-450/000-002



Item no.: 770-450/000-005
Marker card; for manual marking

www.wago.com/770-450/000-005

Item no.: 770-450/000-006
Marker card; for manual marking

www.wago.com/770-450/000-006



Item no.: 770-450/000-012
Marker card; for manual marking

www.wago.com/770-450/000-012

protection

Item no.: 770-201
Lockout cap; for socket; 12-pole; separable

www.wago.com/770-201

Item no.: 770-221
Lockout cap; for socket; 12-pole; separable

www.wago.com/770-221

Downloads

Documentation

Bid Text

770-203 WINSTA MIDI 3-polig	Feb 1, 2016	DOC 24.1 kB	Download
--------------------------------	-------------	----------------	----------

smartDATA

CAD data

3D Download 770-203	URL	Download
---------------------	-----	----------

Subject to changes.