

used for: D-SUB

No. of pos.	(d)	(d)	(d)	(d)	∅E	Part No. Bulk package	Part No. Single package
	A	B	C	D			
9	31.0	25.0	35.5	14.8	12.1	165X11609X	165X11609XE
15	39.4	33.3	40.0	14.8	12.1	165X11619X	165X11619XE
25	53.2	47.0	40.0	14.8	12.1	165X11629X	165X11629XE
37	69.6	63.5	40.0	14.8	12.1	165X11639X	165X11639XE
50	67.0	61.1	42.0	17.6	14.6	165X11649X	165X11649XE

9pos. (c) (f)

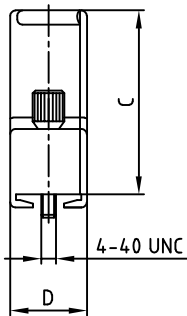
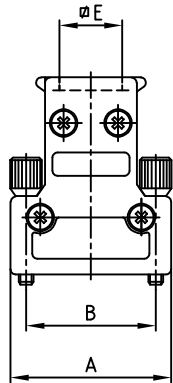

15pos. (c) (f)

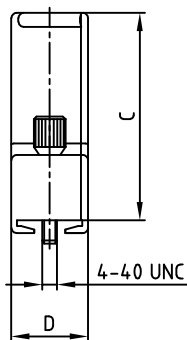
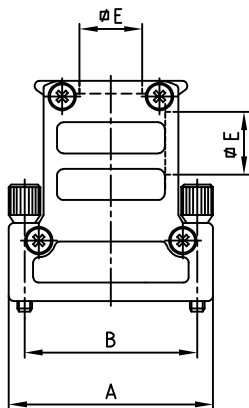

25-50pos. (c) (f)

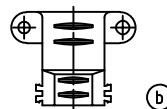
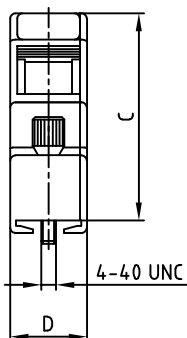
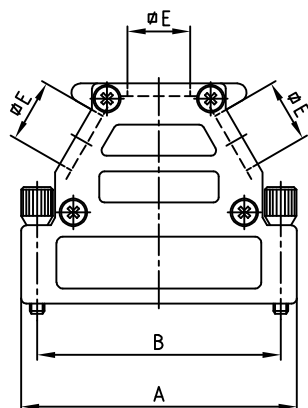

Cable clamp has to be ordered separately.
9-37 pos. Part-no. 160X11189X
50 pos. Part-no. 160X11199X

- (e) Delivery includes:
- Hood with cover
 - Blanking plug:
 - 9pos.: without blanking plug
 - 15pos.: with 1 blanking plug
 - 25-50pos.: with 2 blanking plugs
 - 4 screws for fixing
 - 1 earth screw
 - 2 jack screws

RoHS compliant

THIS DRAWING MAY NOT BE COPIED OR REPRODUCED IN ANY WAY, AND MAY NOT BE PASSED ON TO A THIRD PARTY, WITHOUT WRITTEN PERMISSION. OWNERSHIP AND COPYRIGHT OF CONEC GmbH DO NOT ALTER CAD DRAWING BY HAND

rev.	description	date	name	tolerance	dim. in mm
3 x f	Ä 20-0414	13.10.20	JLE	2002	date
1 x e	Ä 4037	06.07.11	Lehmen	drawn	29.01.
4 x d	Ä 3657	18.05.10	Lehmen	appd.	30.01.
4 x c	Ä 2754	23.07.07	Lehmen	norm	
1 x b	Ä 2459	13.03.06	HS	d-old	
a	Original				



scale:	1:1
material:	HOOD WITH COVER: DIE-CAST ZINC
title:	METAL HOOD EMI/RFI SHIELDING 9-50pos. with jack screws 4-40 UNC
dwg no:	16K1A462A
part no:	SEE TABLE

DIN-A
3
sh:1/1