

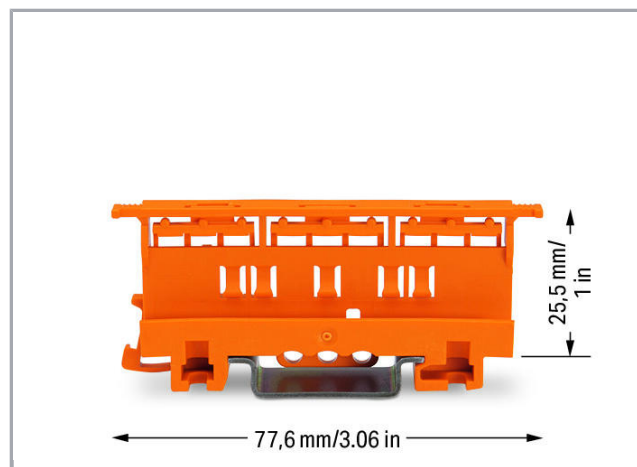

Datový list | Objednací číslo: 221-500

Mounting carrier; 221 Series - 4 mm²; for DIN-35 rail mounting/screw mounting; orange

www.wago.com/221-500

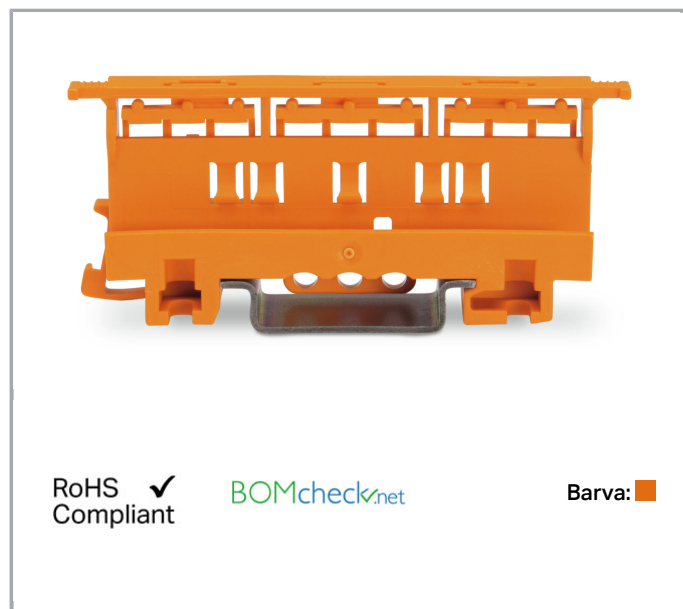

Data

Geometrické údaje

Šířka	17,5 mm / 0.689 inch
Výška od horní hrany lišty DIN 35	25,5 mm / 1.004 inch
Hloubka	77,6 mm / 3.055 inch

Mechanické parametry

Způsob montáže	Lišta DIN 35 Šroubová montáž
Suitable	für 2-, 3-, 5-Leiter-Verbindungsklemmen (4 mm ²) der Serie 221

Údaje o materiálu

barva	Oranžová
Izolační materiál	Polyamid 66 (PA 66)
Třída hořlavosti dle UL94	V0
Hmotnost	9,6 g

Změny vyhrazeny. Berte prosím na vědomí také informace z produktové dokumentace!

WAGO Elektro spol. sr. o.
Rozvodova 1116/36
143 00 Praha 12 - Modřany
Tel.: +420 261 090 143
Email: info.cz@wago.com, wago-cz@wago.com

Máte otázky ohledně našich produktů?
Kdykoli nám zavolejte na číslo +420 261 090 143.



Datový list | Objednávací číslo: 221-500

www.wago.com/221-500

Obchodní údaje

Druh balení	BOX
Country of origin	CN
GTIN	4055143421942
Customs tariff number	39269097900

Kompatibilní produkty

Mounting adapter



Obj. č.: 222-505

Strain relief plate; for mounting carrier; 221 or 222 Series, can be snapped

www.wago.com/222-505



Obj. č.: 222-510

Angled DIN-rail adapter; in combination with mounting carrier; 221-500 or 222-500; for DIN-35 rail mounting; gray

www.wago.com/222-510

Marking accessories

Obj. č.: 210-833

Marking strips; on reel; 6 mm wide; plain; Self-adhesive; white

www.wago.com/210-833

Ke stažení

CAD/CAE-Data

CAD data

2D/3D Models 221-500	URL	Stáhnout
----------------------	-----	----------

CAE data

EPLAN Data Portal 221-500	URL	Stáhnout
---------------------------	-----	----------

ZUKEN Portal 221-500	URL	Stáhnout
----------------------	-----	----------

Pokyny k instalaci

Conductor termination

Změny vyhrazeny. Berte prosím na vědomí také informace z produktové dokumentace!

WAGO Elektro spol. sr. o.
Rozvodova 1116/36
143 00 Praha 12 - Modřany
Tel.: +420 261 090 143

Email: info.cz@wago.com, wago-cz@wago.com

Máte otázky ohledně našich produktů?

Kdykoli nám zavolejte na číslo +420 261 090 143.

www.pewtronic.com



Datový list | Objednáací číslo: 221-500

www.wago.com/221-500

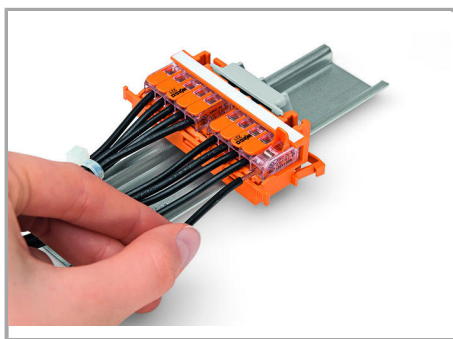

CAGE CLAMP® connection:

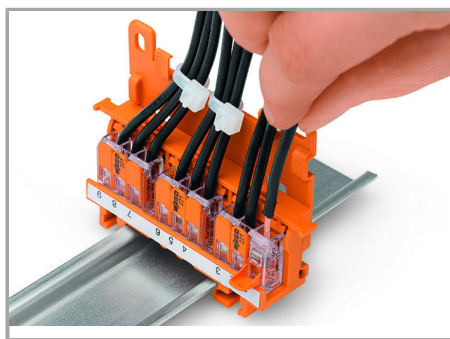

Removing a conductor.

Conductor termination with connectors fitted in a mounting carrier

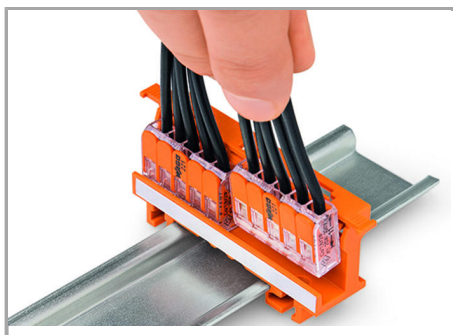

Inserting a connector into the mounting carrier.

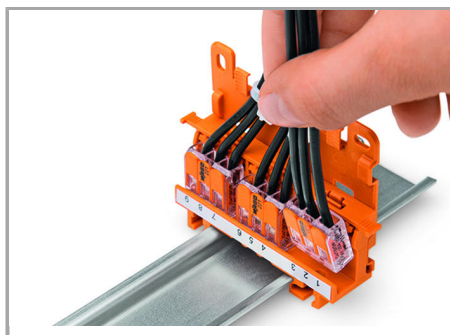

Inserting a connector into the mounting carrier.

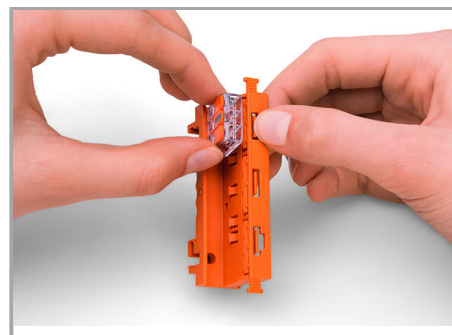

Removing a connector from the mounting carrier.

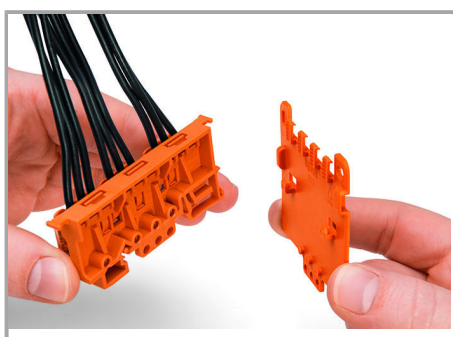

Securing a strain relief plate (222-505) to the mounting carrier.

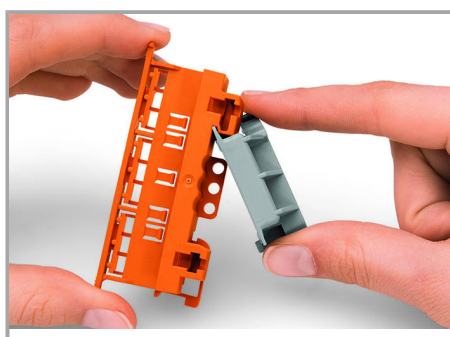

Snapping the angled DIN-rail adapter (222-510) onto the mounting carrier.



Horizontal mounting on DIN-35 rail using an angled DIN-rail adapter.

Změny vyhrazeny. Berte prosím na vědomí také informace z produktové dokumentace!

WAGO Elektro spol. sr. o.
Rozvodova 1116/36
143 00 Praha 12 - Modřany
Tel.: +420 261 090 143
Email: info.cz@wago.com, wago-cz@wago.com

Máte otázky ohledně našich produktů?
Kdykoli nám zavolejte na číslo +420 261 090 143.

Datový list | Objednáací číslo: 221-500

www.wago.com/221-500

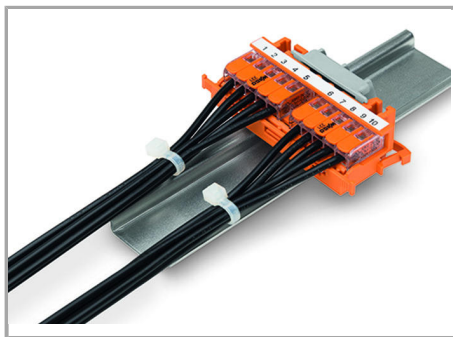

Horizontal mounting on DIN-35 rail using an angled DIN-rail adapter.

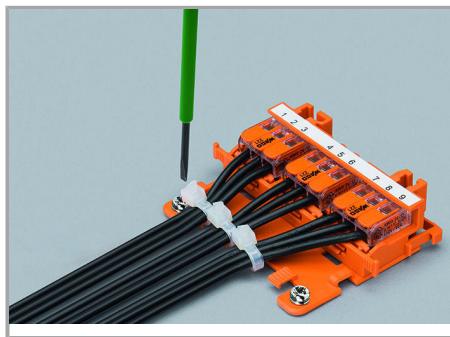

Horizontal screw mounting with strain relief plate on a flat surface



Vertical mounting with strain relief plate on DIN-35 rail.

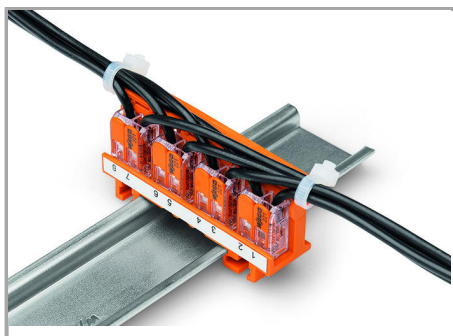

Strain relief via cable ties on the mounting carrier (transverse to the connectors' wiring direction) – clamping units labeled via marking strips (210-334).

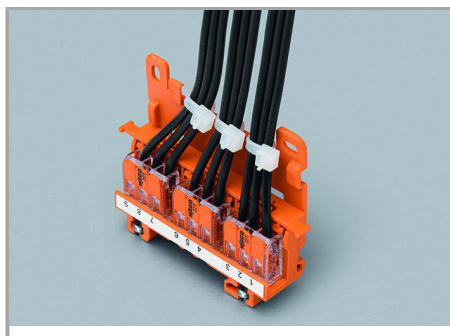

Vertical screw mounting with strain relief plate on a flat surface.

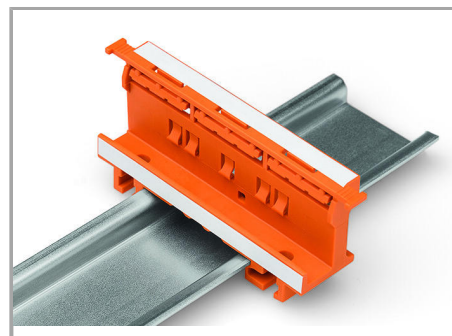

Mounting carrier on a DIN-35 rail

Testing

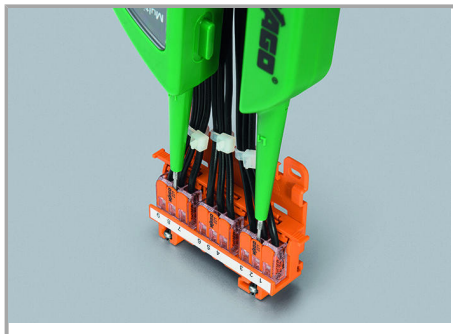

Testing connectors via test slots on top of the carrier.

Změny vyhrazeny. Berte prosím na vědomí také informace z produktové dokumentace!

WAGO Elektro spol. sr. o.
Rozvodova 1116/36
143 00 Praha 12 - Modřany
Tel.: +420 261 090 143
Email: info.cz@wago.com, wago-cz@wago.com

Máte otázky ohledně našich produktů?
Kdykoli nám zavolejte na číslo +420 261 090 143.