

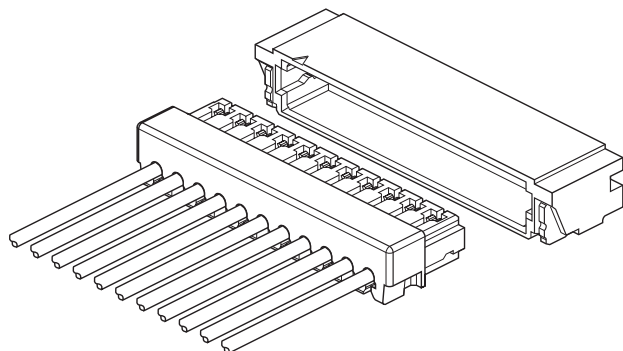

XSR CONNECTOR

0.6mm pitch/Disconnectable Insulation displacement connectors

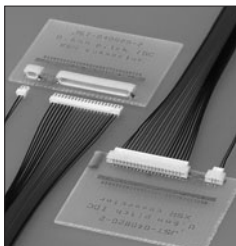

This is the world's smallest 0.6mm pitch ID connector for discrete wires.
This Wire to Board miniaturized connector has a mounting height of 1.45mm and depth of 3.0mm.

- Space saving
- Twin U-slot insulation displacement section
- New strain relief structure
- Suitable for thin wires
- Applicable to automatic ID machines

Specifications

- Current rating: 0.2A AC, DC
- Voltage rating: 30V AC, DC
- Temperature range: -25°C to +85°C
(including temperature rise in applying electrical current)
- Contact resistance: Initial value/ 30m Ω max.
After environmental testing/ 50m Ω max.
- Insulation resistance: 100M Ω min.
- Withstanding voltage: 200V AC/minute
- Applicable wire: Conductor size/ AWG #36
Conductor/ 7 strands,
tin-coated copper alloy
Insulation O.D./ 0.29mm

* Compliant with RoHS.

* Refer to "General Instruction and Notice when using Terminals and Connectors" at the end of this catalog.

* Contact JST for details.

Standards

Ⓡ Recognized E60389

Ⓢ Certified LR20812

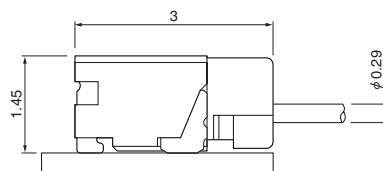
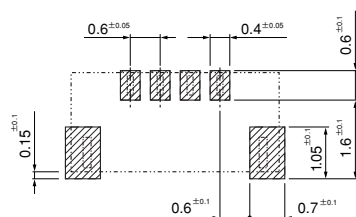

- Note: 1. The above figure is the figure viewed from the connector mounting side.
 2. Tolerances are non-cumulative: ±0.05mm for all centers.
 3. The dimensions above should serve as a guideline. Contact JST for details.

XSR CONNECTOR

Socket

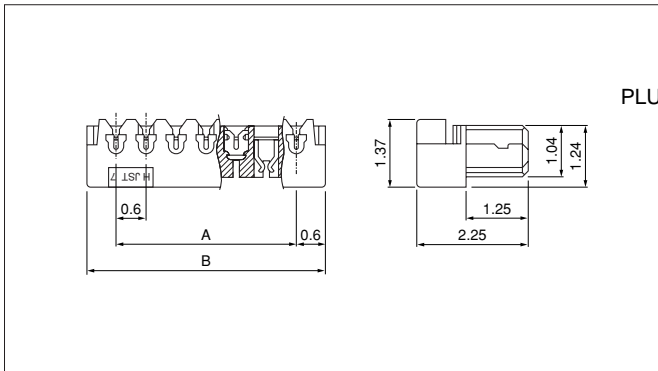

PLU021085

Circuits	Model No.	Dimensions (mm)		Qty / box
		A	B	
2	02XSR-36S	0.6	1.8	4,000
4	04XSR-36S	1.8	3.0	4,000
6	06XSR-36S	3.0	4.2	4,000
10	10XSR-36S	5.4	6.6	4,000
16	16XSR-36S	9.0	10.2	4,000
20	20XSR-36S	11.4	12.6	4,000
22	*22XSR-36S	12.6	13.8	4,000

Material and Finish

Contact: Copper alloy, tin-plated (reflow treatment)

Housing: PA, UL94V-0, natural

RoHS compliance

Note: *Marked products are not UL/CSA approved.

<For reference> As the color identification, the following alphabet shall be put in the underlined part. For availability, delivery and minimum order quantity, contact JST.

ex. **02XSR-36S**

S...natural (standard color)

LG...light green LP...light purple L...lemon yellow

PK...pink LE...light blue O...orange

Header

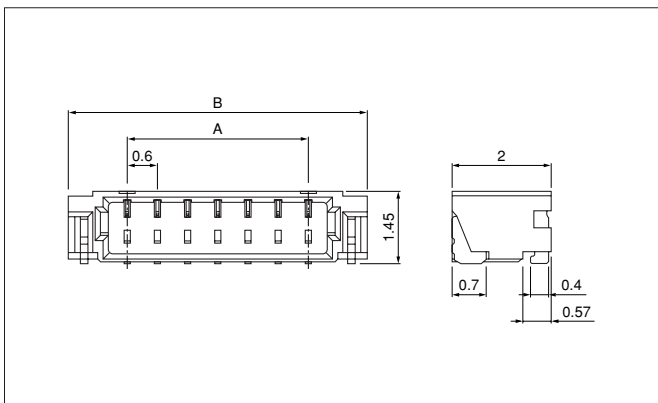

Circuits	Model No.	Dimensions (mm)		Qty / reel
		A	B	
2	SM02B-XSRS-ETB	0.6	3.0	3,500
4	SM04B-XSRS-ETB	1.8	4.2	3,500
6	SM06B-XSRS-ETB	3.0	5.4	3,500
10	SM10B-XSRS-ETB	5.4	7.8	3,500
16	SM16B-XSRS-ETB	9.0	11.4	3,500
20	SM20B-XSRS-ETB	11.4	13.8	3,500
22	*SM22B-XSRS-ETB	12.6	15.0	3,500

Material and Finish

Contact: Copper alloy, copper-undercoated, tin-plated (reflow treatment)

Housing: PA, UL94V-0, natural

Solder tab: Brass, copper-undercoated, tin-plated (reflow treatment)

RoHS compliance This product displays (LF)(SN) on a label.

Note: 1. This products listed above are supplied on embossed-tape.

2. *Marked products are not UL/CSA approved.

<For reference> As the color identification, the following alphabet shall be put in the underlined part. For availability, delivery and minimum order quantity, contact JST.

ex. **SM02B-XSRS-ETB**

S...natural (standard color)

LG...light green LP...light purple L...lemon yellow

PK...pink LE...light blue O...orange