

Konektory krimpovací PAW, PXH, RM=2,00mm

PAW2103, PAWR2103 a PXH2003

rozteč pinů:	2.00mm	AC/DC max. napětí:	100V
počet pinů:	2 až 16	AC/DC max. proud:	2A
prac. teplota:	-25-+85°C	zkušební napětí:	800V AC / 1min
Ri:	>1000MΩ	dop.otvor v DSP	0.80mm nebo SMD
barva:	bílá	průřez vodiče:	AWG22+AWG28
povrch kontaktu:	Sn	vnější Ø izolace [mm]:	max ???
odpor kontaktu:	20mΩ		



Kcr PXH2003-08

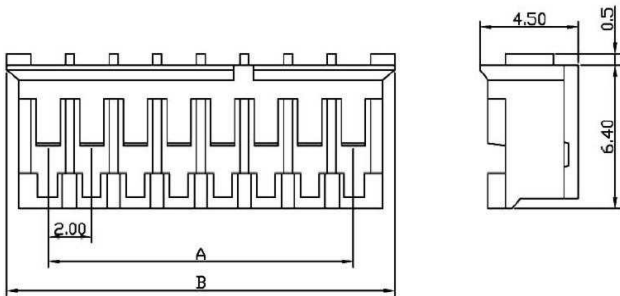
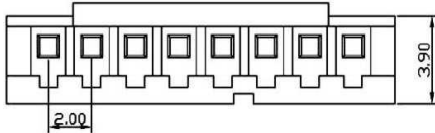

Kcr KONTAKT-PXH2003

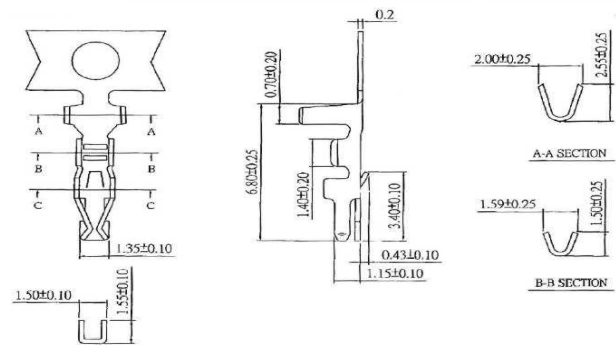

Objednací název zásuvka	Počet pinů	A [mm]	B [mm]	kontakt	protikus			
					vývodové		SMD	
					vidlice - 180°	vidlice - 90°	vidlice - 180°	vidlice - 90°
Kcr PXH2003-02	02	2.00	5.8	Kcr KONTAKT-PXH2003 Sn	Obj. název	Obj. název	Obj. název	Obj. název
Kcr PXH2003-03	03	4.00	7.8		Kcr PAW2103-02	Kcr PAWR2103-02	Kcr: PAW2103-02	Kcr: PAWR2103-02
Kcr PXH2003-04	04	6.00	9.8		Kcr PAW2103-03	Kcr PAWR2103-03	Kcr: PAW2103-03	Kcr: PAWR2103-03
Kcr PXH2003-05	05	8.00	11.8		Kcr PAW2103-04	Kcr PAWR2103-04	Kcr: PAW2103-04	Kcr: PAWR2103-04
Kcr PXH2003-06	06	10.00	13.8		Kcr PAW2103-05	Kcr PAWR2103-05	Kcr: PAW2103-05	Kcr: PAWR2103-05
Kcr PXH2003-07	07	12.00	15.8		Kcr PAW2103-06	Kcr PAWR2103-06	Kcr: PAW2103-06	Kcr: PAWR2103-06
Kcr PXH2003-08	08	14.00	17.8		Kcr PAW2103-07	Kcr PAWR2103-07	Kcr: PAW2103-07	Kcr: PAWR2103-07
Kcr PXH2003-09	09	16.00	19.8		Kcr PAW2103-08	Kcr PAWR2103-08	Kcr: PAW2103-08	Kcr: PAWR2103-08
Kcr PXH2003-10	10	18.00	21.8		Kcr PAW2103-09	Kcr PAWR2103-09	Kcr: PAW2103-09	Kcr: PAWR2103-09
Kcr PXH2003-11	11	20.00	23.8		Kcr PAW2103-10	Kcr PAWR2103-10	Kcr: PAW2103-10	Kcr: PAWR2103-10
Kcr PXH2003-12	12	22.00	25.8		Kcr PAW2103-11	Kcr PAWR2103-11	Kcr: PAW2103-11	Kcr: PAWR2103-11
Kcr PXH2003-13	13	24.00	27.8		Kcr PAW2103-12	Kcr PAWR2103-12	Kcr: PAW2103-12	Kcr: PAWR2103-12
Kcr PXH2003-14	14	26.00	29.8		Kcr PAW2103-13	Kcr PAWR2103-13	Kcr: PAW2103-13	Kcr: PAWR2103-13
Kcr PXH2003-15	15	28.00	31.8		Kcr PAW2103-14	Kcr PAWR2103-14	Kcr: PAW2103-14	Kcr: PAWR2103-14
Kcr PXH2003-16	16	30.00	33.8		Kcr PAW2103-15	Kcr PAWR2103-15	Kcr: PAW2103-15	Kcr: PAWR2103-15
						Kcr PAW2103-16	Kcr PAWR2103-16	Kcr: PAW2103-16

Kcr PAW2103-08 » (protikus PXH2003)

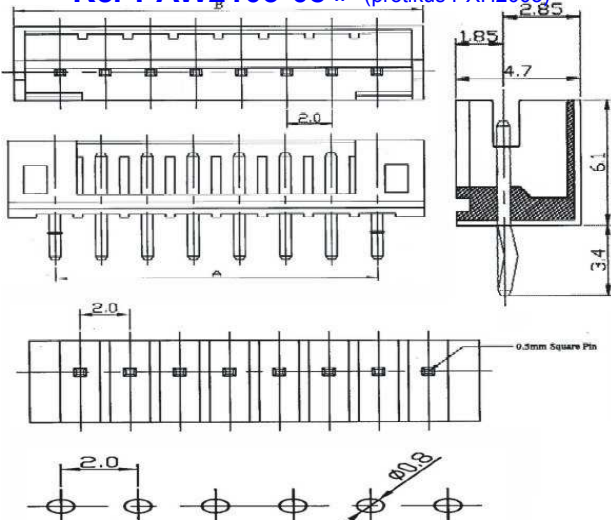

Počet pinů	A(mm)	B(mm)
02	2.00	6.1
03	4.00	8.1
04	6.00	10.1
05	8.00	12.1
06	10.00	14.1
07	12.00	16.1
08	14.00	18.1
09	16.00	20.1
10	18.00	22.1
11	20.00	24.1
12	22.00	26.1
13	24.00	28.1
14	26.00	30.1
15	28.00	32.1
16	30.00	34.1

Konektory krimpovací PAW, PXH, RM=2,00mm

Kcr PAWR2103-08 » (protikus PXH2003)

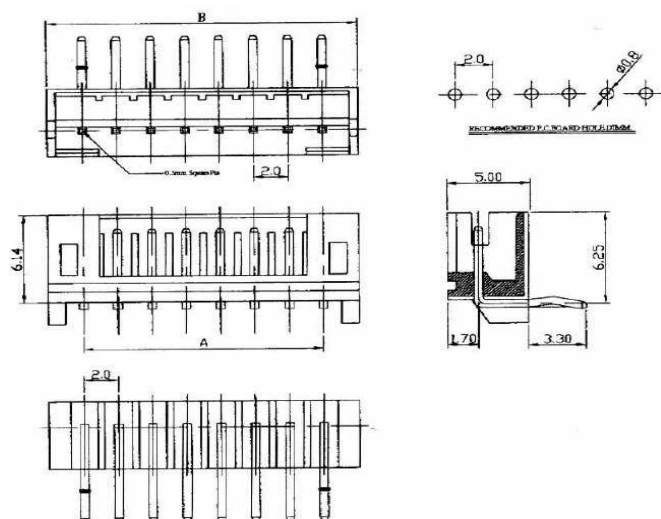

Počet pinů	A(mm)	B(mm)
02	2.00	6.04
03	4.00	8.04
04	6.00	10.04
05	8.00	12.04
06	10.00	14.06
07	12.00	16.06
08	14.00	18.08
09	16.00	20.08
10	18.00	22.10
11	20.00	24.10
12	22.00	26.12
13	24.00	28.12
14	26.00	30.14
15	28.00	32.14
16	30.00	34.14

Kcr: PAW2103-05 » (protikus PXH2003)

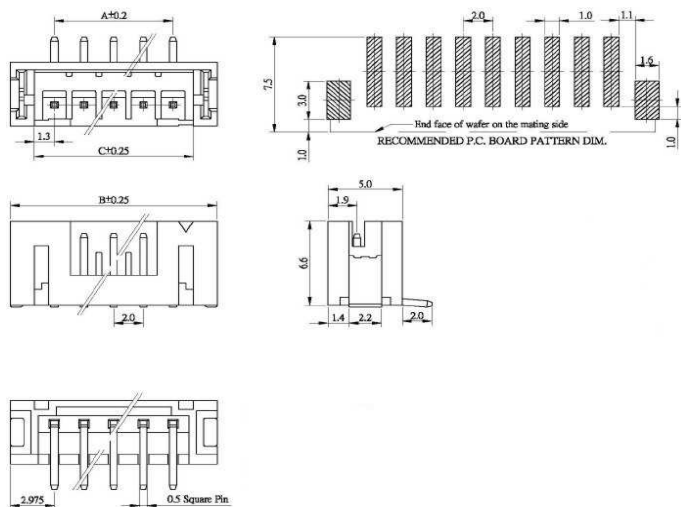

Počet pinů	A(mm)	B(mm)	C(mm)
02	2.00	8.0	4.8
03	4.00	10.0	6.8
04	6.00	12.0	8.8
05	8.00	14.0	10.8
06	10.00	16.0	12.8
07	12.00	18.0	14.8
08	14.00	20.0	16.8
09	16.00	22.0	18.8
10	18.00	24.0	20.8
11	20.00	26.0	22.8
12	22.00	28.0	24.8
13	24.00	30.0	26.8
14	26.00	32.0	28.8
15	28.00	34.0	30.8
16	30.00	36.0	32.8

Kcr: PAWR2103-05 » (protikus PXH2003)

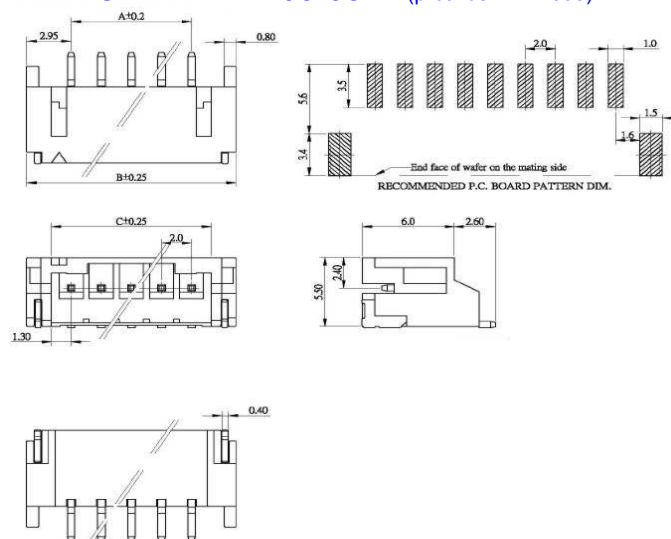

Počet pinů	A(mm)	B(mm)
02	2.00	7.9
03	4.00	9.9
04	6.00	11.9
05	8.00	13.9
06	10.00	15.9
07	12.00	17.9
08	14.00	19.9
09	16.00	21.9
10	18.00	23.9
11	20.00	25.9
12	22.00	27.9
13	24.00	29.9
14	26.00	31.9
15	28.00	33.9
16	30.00	35.9

Konektory krimpovací PAW, PXH, RM=2,00mm

PAW2103, PAWR2103 a PXH2003 - DVOUŘADÉ

Kcr PAW2103 - 05 Sn
 série typ počet pinů materiál pinů

rozteč pinů: 2.00mm
 počet pinů: 6 až 32
 prac. teplota: -25+85°C
 izolační odpor: >1000MΩ
 barva: bílá
 povrch kontaktu: Sn

AC/DC napětí: 250V
 AC/DC proud: 2A
 zkušební napětí: 500V AC / 1min
 dop.otvor v DSP: 0.80mm
 průřez vodiče: AWG22+AWG28
 vnější Ø izolace [mm]: max ???



Kcr PXH2003-04x2

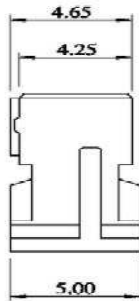
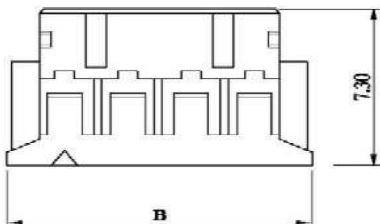
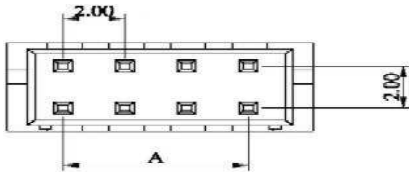

Kcr KONTAKT-PXH2003

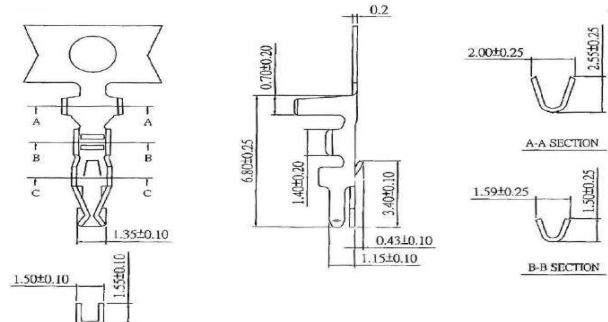

Objednáací název zásuvka	Počet pinů	A [mm]	B [mm]	kontakt	protikus			
					vidlice - 180°		vidlice - 90°	
					Obj. název	B(mm)	Obj. název	B(mm)
Kcr PXH2003-03x2	2x3	4.0	7.90	Kcr KONTAKT-PXH 2003 Sn	Kcr PAW2103-03x2	8.0	Kcr PAWR2103-03x2	8.0
Kcr PXH2003-04x2	2x4	6.0	9.90		Kcr PAW2103-04x2	10.0	Kcr PAWR2103-04x2	10.0
Kcr PXH2003-05x2	2x5	8.0	11.90		Kcr PAW2103-05x2	12.0	Kcr PAWR2103-05x2	12.0
Kcr PXH2003-06x2	2x6	10.0	13.90		Kcr PAW2103-06x2	14.0	Kcr PAWR2103-06x2	14.0
Kcr PXH2003-07x2	2x7	12.0	15.90		Kcr PAW2103-07x2	16.0	Kcr PAWR2103-07x2	16.0
Kcr PXH2003-08x2	2x8	14.0	17.90		Kcr PAW2103-08x2	18.0	Kcr PAWR2103-08x2	18.0
Kcr PXH2003-09x2	2x9	16.0	19.90		Kcr PAW2103-09x2	20.0	Kcr PAWR2103-09x2	20.0
Kcr PXH2003-10x2	2x10	18.0	21.90		Kcr PAW2103-10x2	22.0	Kcr PAWR2103-10x2	22.0
Kcr PXH2003-11x2	2x11	20.0	23.90		Kcr PAW2103-11x2	24.0	Kcr PAWR2103-11x2	24.0
Kcr PXH2003-12x2	2x12	22.0	25.90		Kcr PAW2103-12x2	26.0	Kcr PAWR2103-12x2	26.0
Kcr PXH2003-13x2	2x13	24.0	27.90		Kcr PAW2103-13x2	28.0	Kcr PAWR2103-13x2	28.0
Kcr PXH2003-14x2	2x14	26.0	29.90		Kcr PAW2103-14x2	30.0	Kcr PAWR2103-14x2	30.0
Kcr PXH2003-15x2	2x15	28.0	31.90		Kcr PAW2103-15x2	32.0	Kcr PAWR2103-15x2	32.0
Kcr PXH2003-16x2	2x16	30.0	33.90		Kcr PAW2103-16x2	34.0	Kcr PAWR2103-16x2	34.0

Kcr PAW2103-08x2 » (protikus PXH2003)

Kcr PAWR2103-08x2 » (protikus PXH2003)

