

4B1H_1

Konektory krimpovací PAW, PXH, RM=3.96mm

aktualizace: 18.11.2009

PAW3966, PAWR3966 a PXH3967

rozteč pinů:	3.96mm	AC/DC max. napětí:	250V
počet pinů:	2 až 14	AC/DC max. proud:	5A
prac. teplota:	-25-+85°C	zkušební napětí:	1500V AC / 1min
Ri:	>1000MΩ	dop.otvor v DSP	1.14mm
barva:	bílá	průřez vodiče:	AWG18÷AWG22
povrch kontaktu:	Sn	vnější Ø izolace [mm]:	max ???

Kcr PAW3966 - 05 Sn

série typ počet pinů materiál pinů

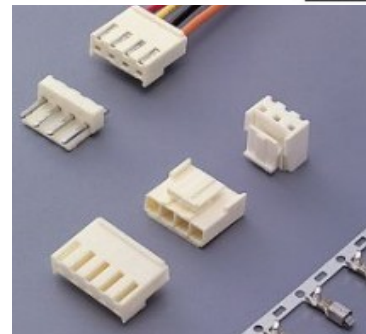

Kcr PXH3967-08

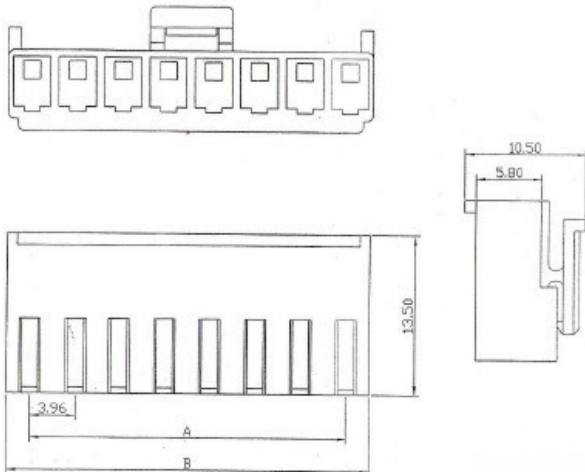

Kcr KONTAKT-PXH3967

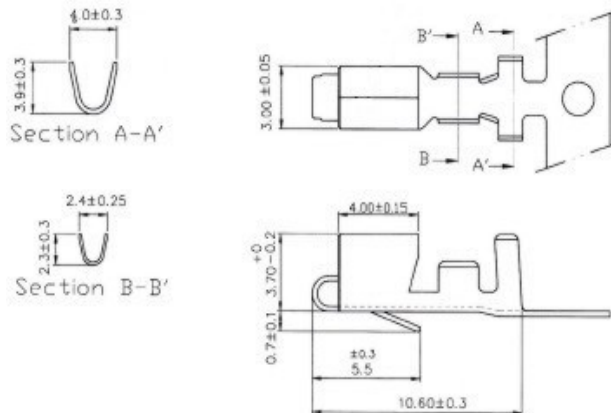

Objednáací název zásuvka	Počet pinů	A [mm]	B [mm]	kontakt	protikus					
					vidlice - 180°		vidlice - 90°			
					Obj. název	A(mm)	B(mm)		A(mm)	B(mm)
Kcr PXH3967-02	2	3.96	8.04	Kcr KONTAKT-PXH3967	Kcr PAW3966-02	3.96	7.92	Kcr PAWR3966-02	3.96	7.92
Kcr PXH3967-03	3	7.92	12.10		Kcr PAW3966-03	7.92	11.92	Kcr PAWR3966-03	7.92	11.92
Kcr PXH3967-04	4	11.88	15.96		Kcr PAW3966-04	11.88	15.84	Kcr PAWR3966-04	11.88	15.84
Kcr PXH3967-05	5	15.84	20.00		Kcr PAW3966-05	15.84	19.84	Kcr PAWR3966-05	15.84	19.84
Kcr PXH3967-06	6	19.80	23.90		Kcr PAW3966-06	19.80	23.80	Kcr PAWR3966-06	19.80	23.80
Kcr PXH3967-07	7	23.76	27.90		Kcr PAW3966-07	23.76	27.88	Kcr PAWR3966-07	23.76	27.88
Kcr PXH3967-08	8	27.72	31.86		Kcr PAW3966-08	27.72	31.74	Kcr PAWR3966-08	27.72	31.74
Kcr PXH3967-09	9	31.68	35.88		Kcr PAW3966-09	31.68	35.86	Kcr PAWR3966-09	31.68	35.86
Kcr PXH3967-10	10	35.64	39.84		Kcr PAW3966-10	35.64	39.90	Kcr PAWR3966-10	35.64	39.90
Kcr PXH3967-11	11	39.60	43.74		Kcr PAW3966-11	39.60	43.84	Kcr PAWR3966-11	39.60	43.84
Kcr PXH3967-12	12	43.56	47.74		Kcr PAW3966-12	43.56	47.92	Kcr PAWR3966-12	43.56	47.92
Kcr PXH3967-13	13	47.52	51.70		Kcr PAW3966-13	47.52	51.72	Kcr PAWR3966-13	47.52	51.72
Kcr PXH3967-14	14	51.48	55.66		Kcr PAW3966-14	51.48	55.92	Kcr PAWR3966-14	51.48	55.92

Kcr PAW3966-08

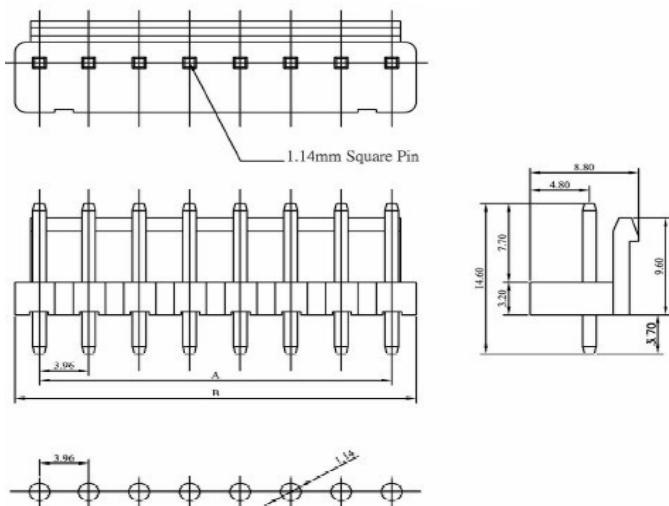

Kcr PAWR3966-08

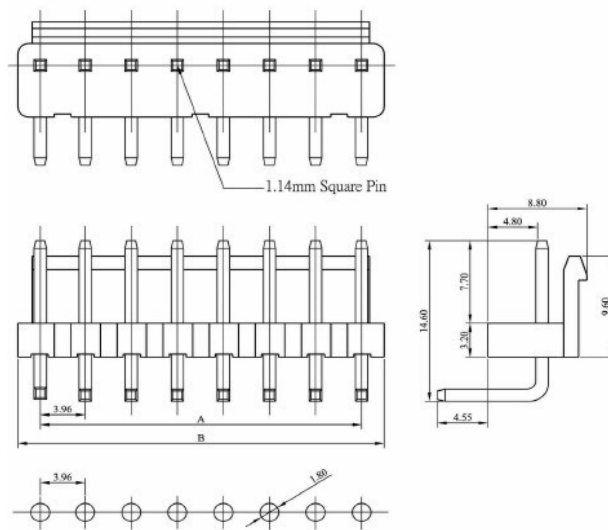

4B1H_2

Konektory krimpovací PAW, PXH, RM=3.96mm

PAW2400, PAWR2400 a PXH2410

rozteč pinů:	3.96mm	AC/DC napětí:	250V
počet pinů:	2 až 20	AC/DC proud:	5A
prac. teplota:	-25-+85°C	zkušební napětí:	1500V AC / 1min
izolační odpor:	>1000MΩ	dop.otvor v DSP	SMD
barva:	bílá	průřez vodiče:	AWG16+AWG20
povrch kontaktu:	Sn	vnější Ø izolace [mm]:	max 2.8
odpor kontaktu	10mΩ		

Kcr PAW2400 - 05 Sn
série typ počet pinů materiál pinů

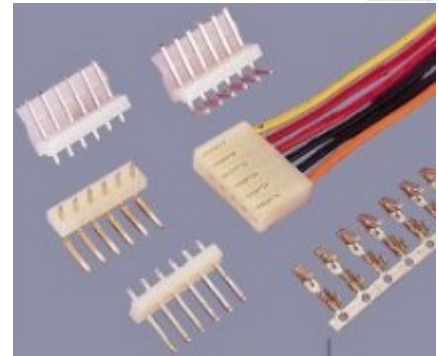

Kcr PXH2410-06

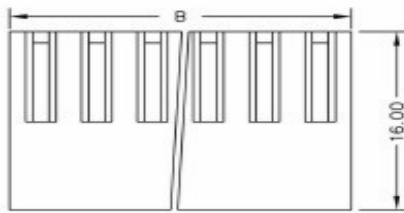
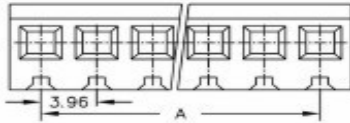

Kcr KONTAKT-PXH2410

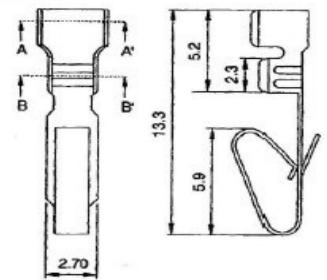
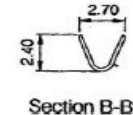
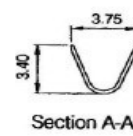

Objednáací název zásuvka	Počet pinů	A [mm]	B [mm]	kontakt	protikus					
					vidlice - 180°			vidlice - 90°		
					Obj. název	A(mm)	B(mm)	Obj. název	A(mm)	B(mm)
Kcr PXH2410-02	02	3.96	8.45	Kcr KONTAKT-PXH2410	Kcr PAW2400-02	3.96	8.00	Kcr PAWR2400-02	3.96	8.00
Kcr PXH2410-03	03	7.92	12.39		Kcr PAW2400-03	7.92	12.00	Kcr PAWR2400-03	7.92	12.00
Kcr PXH2410-04	04	11.88	16.35		Kcr PAW2400-04	11.88	15.90	Kcr PAWR2400-04	11.88	15.90
Kcr PXH2410-05	05	15.84	20.31		Kcr PAW2400-05	15.84	20.00	Kcr PAWR2400-05	15.84	20.00
Kcr PXH2410-06	06	19.80	24.27		Kcr PAW2400-06	19.80	24.00	Kcr PAWR2400-06	19.80	24.00
Kcr PXH2410-07	07	23.76	28.23		Kcr PAW2400-07	23.76	27.90	Kcr PAWR2400-07	23.76	27.90
Kcr PXH2410-08	08	27.72	32.19		Kcr PAW2400-08	27.72	31.90	Kcr PAWR2400-08	27.72	31.90
Kcr PXH2410-09	09	31.68	36.15		Kcr PAW2400-09	31.68	35.80	Kcr PAWR2400-09	31.68	35.80
Kcr PXH2410-10	10	35.64	40.11		Kcr PAW2400-10	35.64	39.90	Kcr PAWR2400-10	35.64	39.90
Kcr PXH2410-11	11	39.60	44.07		Kcr PAW2400-11	39.60	43.90	Kcr PAWR2400-11	39.60	43.90
Kcr PXH2410-12	12	43.56	48.03		Kcr PAW2400-12	43.56	47.80	Kcr PAWR2400-12	43.56	47.80
Kcr PXH2410-13	13	47.52	51.99		Kcr PAW2400-13	47.52	51.80	Kcr PAWR2400-13	47.52	51.80
Kcr PXH2410-14	14	51.48	55.95		Kcr PAW2400-14	51.48	55.70	Kcr PAWR2400-14	51.48	55.70
Kcr PXH2410-15	15	55.44	59.91		Kcr PAW2400-15	55.44	59.80	Kcr PAWR2400-15	55.44	59.80
Kcr PXH2410-16	16	59.40	63.87		Kcr PAW2400-16	59.40	63.80	Kcr PAWR2400-16	59.40	63.80
Kcr PXH2410-17	17	63.36	67.83		Kcr PAW2400-17	63.36	67.70	Kcr PAWR2400-17	63.36	67.70
Kcr PXH2410-18	18	67.32	71.79		Kcr PAW2400-18	67.32	71.70	Kcr PAWR2400-18	67.32	71.70
Kcr PXH2410-19	19	71.28	75.75		Kcr PAW2400-19	71.28	75.60	Kcr PAWR2400-19	71.28	75.60
Kcr PXH2410-20	20	75.24	79.71		Kcr PAW2400-20	75.24	79.80	Kcr PAWR2400-20	75.24	79.80

Kcr PAW2400-06

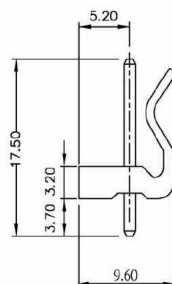
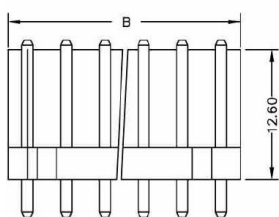
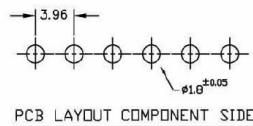
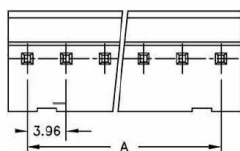

Kcr PAWR2400-08

